

Please write clearly in block capitals.

Centre number

Candidate number

Surname _____

Forename(s) _____

Candidate signature _____

I declare this is my own work.

Functional Skills Level 1

MATHEMATICS

Paper 2 Calculator

Thursday 3 November 2022 Afternoon Time allowed: 1 hour 30 minutes

Materials

For this paper you must have:

- a calculator
- mathematical instruments.



Instructions

- Use black ink or black ball-point pen. Draw diagrams in pencil.
- Answer **all** questions.
- You must answer the questions in the spaces provided. Do not write outside the box around each page or on blank pages.
- If you need extra space for your answer(s), use the lined pages at the end of this book. Write the question number against your answer(s).
- Do all rough work in this book. Cross through any work you do not want to be marked.
- State the units of your answer where appropriate.

Information

- The marks for questions are shown in brackets.
- The maximum mark for this paper is 60.
- You may ask for more answer paper, graph paper and tracing paper. These must be tagged securely to this answer book.

Advice

In all calculations, show clearly how you work out your answer.

For Examiner's Use	
Question	Mark
1–8	
9	
10	
11	
12	
TOTAL	



N 0 V 2 2 8 3 6 1 2 0 1

Section AAnswer **all** questions in the spaces provided.

- 1** A fair six-sided dice is rolled.
Which letter shows the probability of landing on an even number?
Circle your answer.

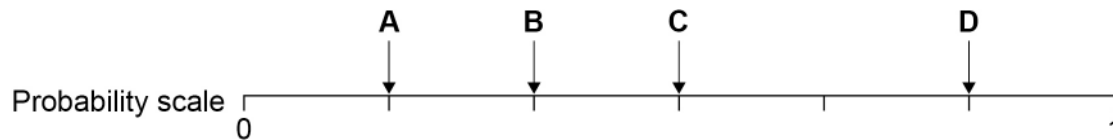
[1 mark]

- 2** Circle the fraction with the same value as $3\frac{3}{4}$

[1 mark]

$\frac{9}{4}$

$\frac{10}{4}$

$\frac{13}{4}$

$\frac{15}{4}$

- 3** Measure the size of angle x

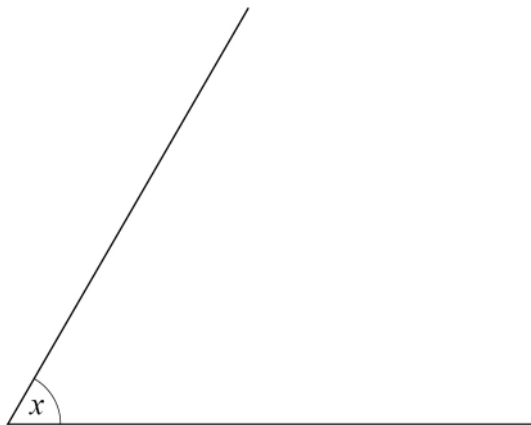
[1 mark]

Answer _____ °



4 Calculate -5×-6

[1 mark]

Answer _____

5 The front elevation and side elevation of a shape are shown.

FRONT ELEVATION

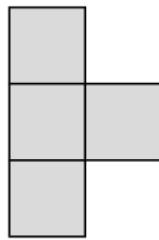

SIDE ELEVATION

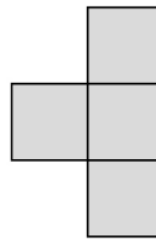

Which shape has these elevations?

Circle the correct letter.

[1 mark]

A

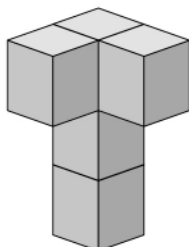

B

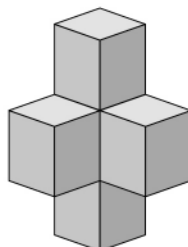

C

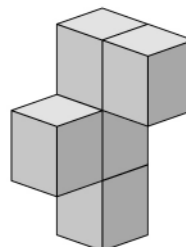

D

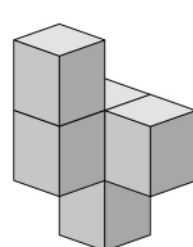

Turn over ►



6 Round 14.76 to one decimal place.

[1 mark]

Answer _____

7 Here are six numbers.

16 19 16 10 17 12

Work out the mean.

[3 marks]

Answer _____

8 Increase 630 by 40%

[3 marks]

Answer _____

12



Section B

Answer **all** questions in the spaces provided.

9 The Kitchen Fitter

Ryan is a kitchen fitter.

- 9 (a)** A customer wants cupboards along one wall of her kitchen.
Ryan can choose from these cupboards.

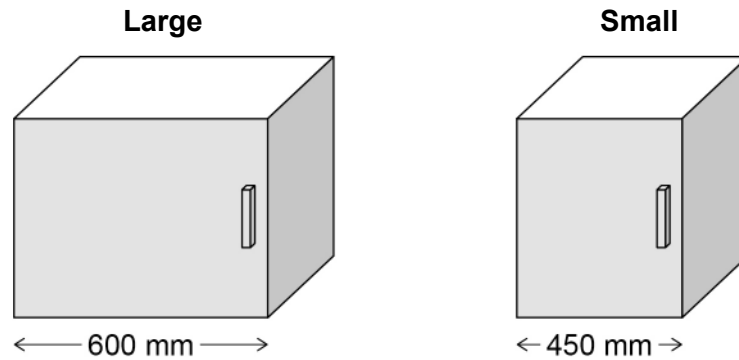

He can choose some of each size.

The length of the wall is 3.45 **metres**.

How many of each cupboard could Ryan choose so that they fit the length of the wall with no gaps?

[4 marks]

Number of large cupboards _____

Number of small cupboards _____

Question 9 continues on the next page

Turn over ►



9 (b) A different customer wants

3 large cupboards with width 600 mm and depth 600 mm

2 small cupboards with width 450 mm and depth 600 mm

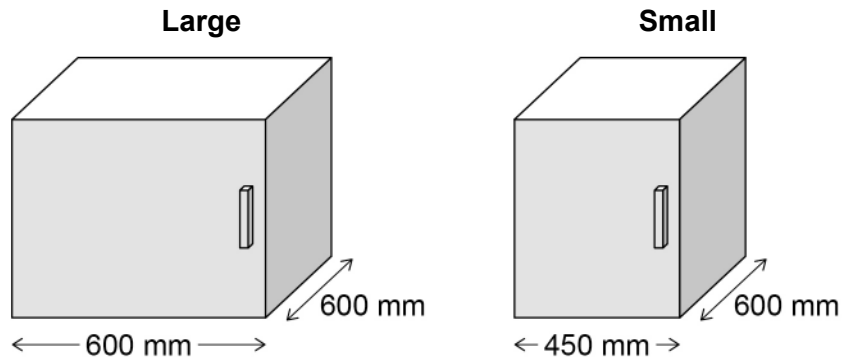

The cupboards will fit along **one** wall of this customer's kitchen.

The grid on the page opposite shows a scale drawing of the kitchen.

The scale is 1 cm represents 150 mm

Use the grid to draw a plan of where Ryan could fit the cupboards.

[4 marks]



Scale: 1 cm represents 150 mm

Wall

Wall

Wall

Wall

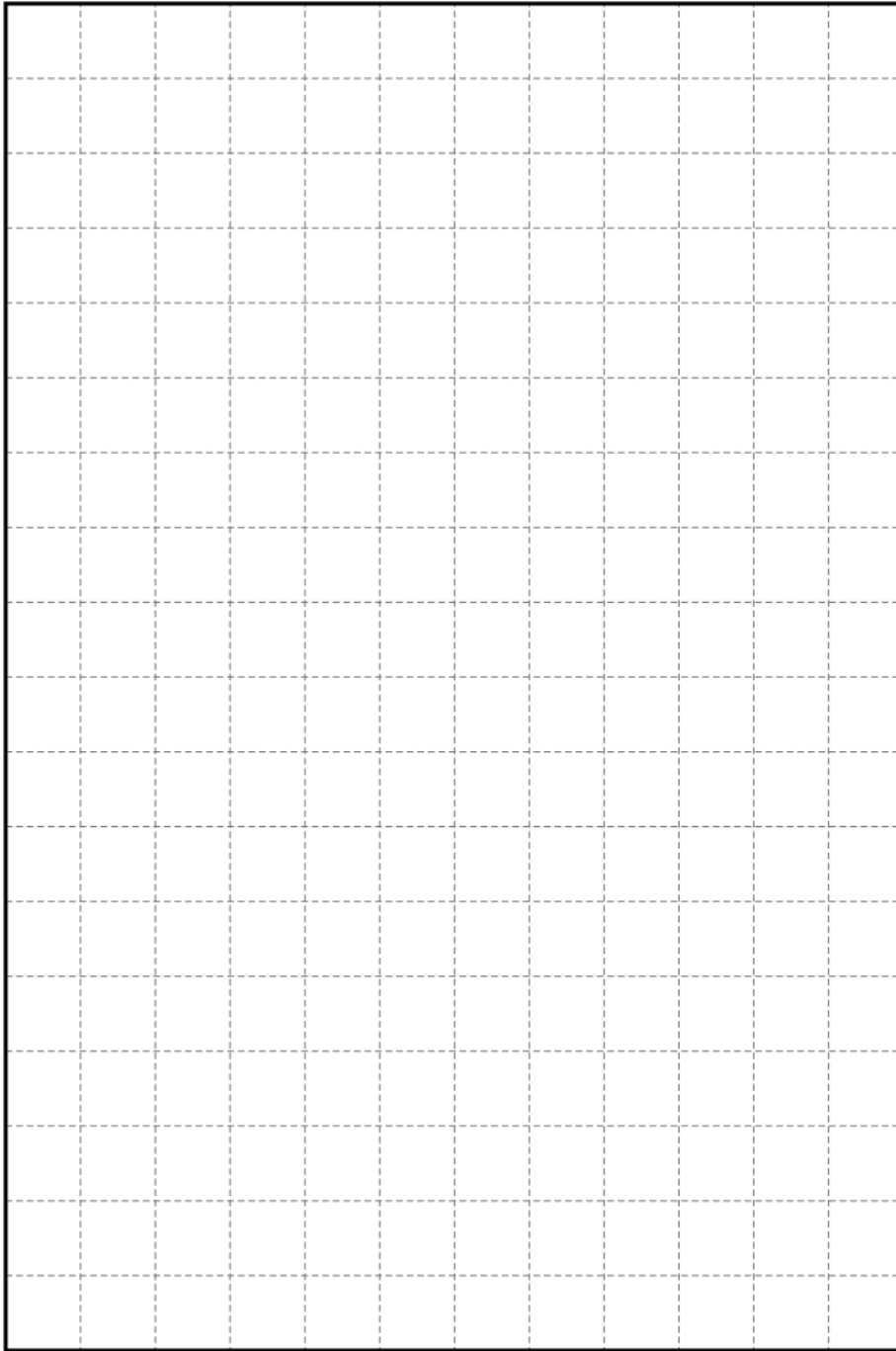

Question 9 continues on the next page

Turn over ►



10 Flower Farm

Erik grows daffodils on his farm.



10 (a) This is a sketch of a field where Erik will grow daffodils.

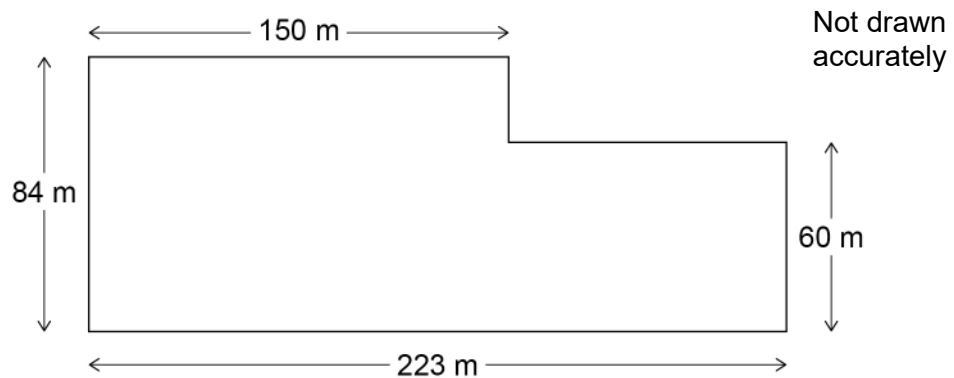

Erik plants 1.25 kg of daffodil bulbs per square metre of land.

He has 20 tonnes of bulbs.

1 tonne = 1000 kg

Does Erik have enough bulbs to plant all of this field?

You **must** show your working.

[5 marks]

Question 10 continues on the next page

Turn over ►



10 (c) Erik plants different types of daffodils in his fields.

Here is some data about the area he planted with each type of daffodil.

Type of daffodil	Area planted (m ²)
Golden Ducat	88 000
White Lion	72 000
Ice Follies	46 000
Pink Pride	34 000

Draw a suitable chart to show this data.

[4 marks]

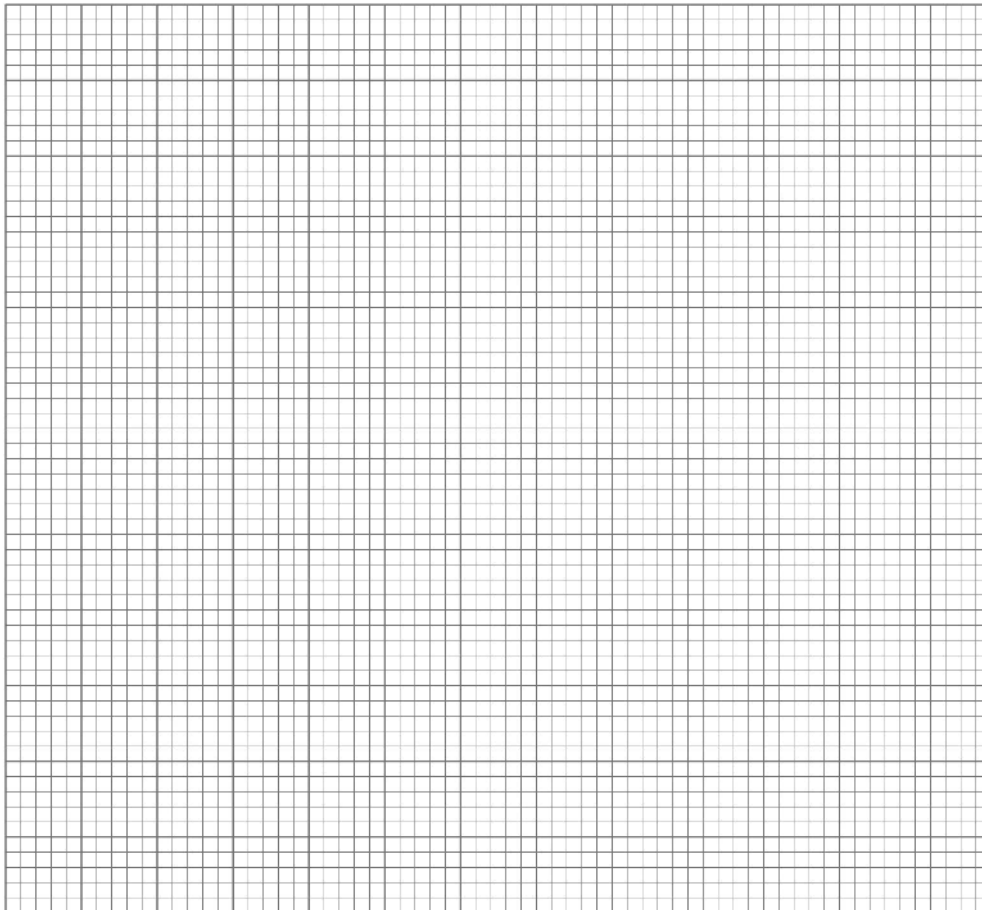

Turn over for the next question

Turn over ►



11 Parcels

Sam sends parcels using couriers.

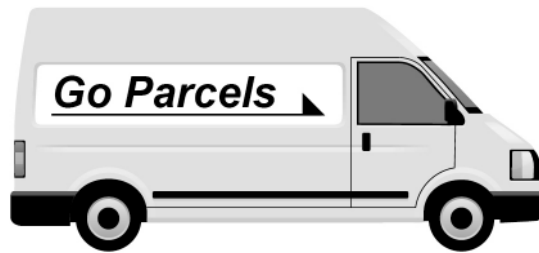

11 (a) The table shows information about the cost of sending parcels with Go Parcels.

Weight range	Cost
Up to 1 kg	£5.99
More than 1 kg up to 10 kg	£12.99
More than 10 kg up to 15 kg	£14.24
More than 15 kg up to 20 kg	£25.49

Sam needs to send items weighing 2 kg, 4 kg and 11 kg

Sam can combine the three items into one parcel before sending.

How much cheaper is it to send one combined parcel rather than three separate parcels?

[4 marks]

Answer £ _____



- 11 (b)** Sam sends a parcel with a different courier, Package Plus.
The parcel is a cuboid box measuring 2 m by 0.4 m by 0.6 m

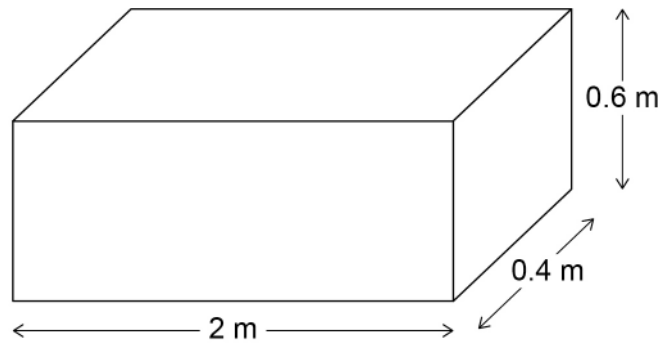

Package Plus charges using the formula

$$\text{Cost (£)} = \text{£}15.25 + (\text{volume of parcel in m}^3 \times \text{£}4.25)$$

Sam pays with a £20 note.

How much change should Sam receive?

[5 marks]

Answer £ _____



12 The Theatre

Amy is going to a theatre show in Chichester.

12 (a) Amy will travel by train to Chichester.

Amy has a railcard that gives her $\frac{1}{3}$ off the normal price of a train ticket.

The normal price of a return ticket to Chichester is £16.83

Amy says,

“My ticket will cost **less than** £11 if I use my railcard.”

Is Amy correct?

You **must** show your working.

[3 marks]



There are no questions printed on this page

*Do not write
outside the
box*

**DO NOT WRITE ON THIS PAGE
ANSWER IN THE SPACES PROVIDED**



